



# The right choice.

**3M™ Abrasives for Right-Angle Systems**

Cut, grind, finish and more... with a world-class abrasive system that helps you work smarter, finish faster!

**FEATURING**

**Scotch-Brite™ Precision Surface Conditioning Discs**

Re-defining non-woven surface conditioning discs!



With Precision Shaped Grains

Your power team  
for metal fabrication  
and finishing.





3M™ Abrasive Discs and Wheels offer innovative solutions for tackling a range of applications. Developed with cutting-edge abrasives technology, these products deliver the performance and quality you need. And we offer a variety of brands and grades to fit your budget and application.

## Table of Contents



<b>3M™ Cubitron™ II and Advanced Series – Selection Guide</b>	6
Depressed Center Grinding Wheels	10
Fibre Discs	12
Flap Discs	16
Cut & Grind Wheels	20
Cut-Off Wheels	22
<b>Scotch-Brite™ – Selection Guide</b>	25
Precision Surface Conditioning Discs	26
SC Surface Conditioning Discs	28
Light Grinding and Blending Discs	29
SE Surface Conditioning Discs	30
Clean & Strip Discs	31
<b>Power Tools and Accessories</b>	34
<b>Single Packs</b>	38



# General Guidelines

## Which series is right for you?

Choose 3M™ Cubitron™ II Abrasives for their legendary speed and long life, or Advanced Series discs and wheels for value-priced performance. Scotch-Brite™ Abrasives deliver consistent, reproducible results, making it easy to ensure quality finishes.

What's most important?	Choose this family of 3M Abrasives
<b>Speed and long life –</b> to improve productivity and lower <u>overall</u> production costs	<b>Premium Series – 3M™ Cubitron™ II Abrasives</b> <b>CUBITRON™ II</b> 
<b>Consistency and ease of use –</b> to improve surfaces without significantly changing the workpiece	<b>Scotch-Brite™ Abrasives</b> <b>Scotch-Brite™</b> 
<b>Value-priced performance –</b> to minimize abrasive spend while getting the job done efficiently	<b>Advanced Series – 3M™ Abrasives</b> <b>3M</b> 

## Bonded wheel product comparisons

Speed and durability rated on a scale of 1 to 5, with 5 stars being the best.



Attributes	Aluminum oxide	Alumina zirconia	3M™ Silver	3M™ Cubitron™ II
Durability / Life	**	***	*****	*****
Speed of Cut	*	**	***	*****
Feel: Smooth	**	***	****	*****
Contaminant-free* (for stainless/inox)	varies	varies	yes	yes
Abrasive Cost per Job	\$\$\$	\$\$	\$	\$\$
Total Cost of Job (Abrasive, Labor, Processes)	\$\$\$\$	\$\$\$	\$\$	\$

\* Contains less than 0.1% Fe, S and Cl

# Complete your lineup.

## Genuine 3M™ Power Tools (See page 34)

These professional grade sanders, grinders and cut-off wheel tools are optimized for use with 3M™ Cubitron™ II Abrasives and 3M™ Abrasives.

**NEW!**

Check out our powerful new pneumatic tools!



## 3M Personal Protective Equipment\*



Light weight, comfortable welding helmet with advanced auto-darkening optics that adjust to your working conditions.

**3M™ Speedglas™ Welding Helmet 9002NC**  
(PN 04-0100-20NC)



Help protect your forehead and face against sparks, chips and debris.

**3M™ Ratchet Headgear Head and Face Protection**  
(PN 82783-00000)



Comfortable eye protection with anti-fog lenses for a clear view of your workpiece.

**3M™ SecureFit™ Protective Eyewear**  
(PN SF401AF)



Quick, comfortable hearing protection that stays clean, even when your hands are dirty.

**3M™ E-A-R™ UltraFit™ Corded Earplugs**  
(PN 340-4004)

\*When properly selected and worn according to the User instructions, 3M Personal Protective Equipment (PPE) helps reduce exposure to certain hazards. Before use, the employer must conduct an appropriate hazard assessment, select and provide appropriate PPE, and the wearer must read and understand the User Instructions provided as a part of the product packaging. Follow all local regulations. Misuse may result in sickness or death. For correct use, consult supervisor and User Instructions, or call 3M Personal Safety Division (PSD) Technical Service in the U.S.A. at 1-800-243-4630. In Canada, call 1-800-267-4414.

## Meet the

# Premium Series

of right angle abrasives  
for unparalleled power  
and performance!

### Featuring:





- 3M™ Cubitron™ II Abrasives for an unbeatable combination of speed and long life
- Scotch-Brite™ Abrasives for ease of use and consistent quality finishes.
- Featuring the Scotch-Brite™ Precision Surface Conditioning Disc; the first non-woven disc with 3M precision shaped grain

	Product	Cutting	Weld Grinding	Back Gouging
	3M™ Cubitron™ II Depressed Center Grinding Wheels		◆	
	3M™ Cubitron™ II Fibre Disc 982CX Pro		◆	
	3M™ Cubitron™ II Fibre Discs 982C & 987C		◆	
	3M™ Cubitron™ II Flap Discs		◆	
	3M™ Cubitron™ II Cut & Grind Wheels	◆	◆	◆
	3M™ Cubitron™ II Cut Off Wheels	◆		
	Scotch-Brite™ Surface Conditioning Discs			
	Scotch-Brite™ Precision Surface Conditioning Disc		◆	
	Scotch-Brite™ SE Surface Conditioning Disc			
	Scotch-Brite™ Light Grinding & Blending Discs		◆	
	Scotch-Brite™ Clean & Strip XT PRO/Extra Cut Discs			

## Introducing the

# Advanced Series

of right angle abrasives  
designed for value-priced  
performance!

	Product	Cutting	Weld Grinding	Back Gouging
	3M™ Silver Depressed Center Grinding Wheels		◆	
	3M™ Fibre Discs 782C/787C		◆	
	3M™ Flap Discs 769F		◆	
	3M™ Silver Cut Off Wheels	◆		
	3M™ Cut & Grind Wheels	◆	◆	◆

◆ Recommended application

Small Weld Grinding	Beveling	Fillet Weld Removal	Heavy Deburring, Slag Removal	Light Deburring/ Edge Break	Blending/ Refining	Weld Prep/ Surface Prep	Finishing
	◆		◆				
	◆		◆				
	◆		◆				
	◆		◆		◆	◆	◆
	◆	◆					
					◆	◆	◆
◆				◆	◆	◆	◆
				◆	◆	◆	
					◆	◆	◆
						◆	◆

Small Weld Grinding	Beveling	Fillet Weld Removal	Heavy Deburring, Slag Removal	Light Deburring/ Edge Break	Blending/ Refining	Weld Prep/ Surface Prep	Finishing
	◆		◆				
	◆		◆				
	◆		◆		◆	◆	◆
◆							
◆	◆	◆					





# Premium Series

Legendary fast-cutting, long-lasting 3M™ Cubitron™ II Abrasives and easy-to-use, consistent Scotch-Brite™ Abrasives – including the first Scotch-Brite disc featuring 3M Precision-Shaped Grain!

**Scotch-Brite™**  
**CUBITRON II**

# Advanced Series

The next-best thing to our Premium Series of 3M™ Cubitron™ II Abrasives, our new Advanced Series harnesses the power of 3M Precision-Shaped Grain and helps minimize your abrasive spend.

**3M**

## Optimized for applications including:

- Beveling
- Blending
- Cutting
- Deburring
- Grinding
- Weld removal

## Used in industries such as:

- Agricultural, industrial and construction machinery
- General metal fabrication
- Oil and gas
- Ship building
- Stainless steel fabrication
- Structural steel

## The Science of Precision-Shaped Grain

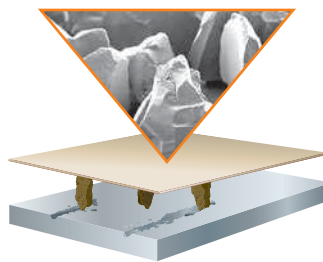

Conventional ceramic abrasive grain tends to “plow” through the metal, causing heat to build up in the workpiece and the abrasive – resulting in a slower cut and shorter abrasive life.

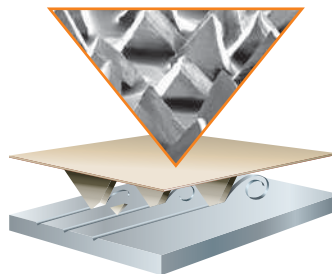

3M Precision-Shaped Grain uses 3M microreplication technology to form sharp peaks that easily “slice” through metal — cutting cooler, faster and lasting longer than conventional abrasive grain.

Experience the power of re-engineered 3M Precision-Shaped Grain: see page 12.

## Premium Series

# 3M™ Cubitron™ II Depressed Center Grinding Wheels

### Go the distance.

3M™ Cubitron™ II Depressed Center Grinding Wheels are fast cutting, long lasting and require less pressure. These cool cutting wheels are ideal for heavy grinding and weld removal. Specially formulated for use on stainless and mild steel. Available with quick change attachment. **DO NOT USE ON TOOLS WITHOUT GUARDS.**

### 3M™ Cubitron™ II Depressed Center Grinding Wheel – T27

Diameter × Thickness × Arbor Hole (inches)	UPC	Max. RPM	Quantity (Inner/Case)
4 × ¼ × ⅜	05115-78469-9	15,300	10/20
4 × ¼ × ⅝	05115-78468-2	15,300	10/20
4½ × ¼ × ⅞	05115-78466-8	13,300	10/20
5 × ¼ × ⅞	05115-78467-5	12,250	10/20
6 × ¼ × ⅞	076308-64314-0	10,200	10/20
7 × ¼ × ⅞	076308-64315-7	8,500	10/20
9 × ¼ × ⅞	076308-64316-4	6,650	10/20

### 3M™ Cubitron™ II Depressed Center Grinding Wheel – T27 Quick Change

Diameter × Thickness × Arbor Hole (inches)	UPC	Max. RPM	Quantity (Inner/Case)
4½ × ¼ × ⅝-11	076308-64320-1	13,300	10/20
5 × ¼ × ⅝-11	076308-64317-1	12,250	10/20
6 × ¼ × ⅝-11	076308-64318-8	10,200	10/20
7 × ¼ × ⅝-11	076308-64319-5	8,500	10/20
9 × ¼ × ⅝-11	051125-87153-2	6,650	10/20



## 3M™ Silver Depressed Center Grinding Wheels

The next-best thing to a 3M™ Cubitron™ II Wheel.  
*And it still beats the competition, hands down.*

3M Silver Depressed Center Grinding Wheels (DCGW) represent a new class of long-lasting right-angle abrasives – powered by the legendary speed and long life of 3M Precision-Shaped Grain and engineered to offer an outstanding value, when abrasive cost takes precedence over reducing total production time. They are an ideal choice for applications like weld removal, beveling, edge chamfering and more – offering a longer life and faster cut than aluminum oxide, alumina zirconia and conventional ceramic abrasives.

### 3M™ Silver Depressed Center Grinding Wheel – T27

Diameter x Thickness x Arbor Hole (inches)	UPC	Max. RPM	Quantity (Inner/Case)
4 x ¼ x ¾	051125-87455-7	15,300	10/20
4 x ¼ x ¾	051125-87456-4	15,300	10/20
4½ x ¼ x ¾	051125-87453-3	13,300	10/20
5 x ¼ x ¾	051125-87454-0	12,250	10/20
6 x ¼ x ¾	051125-87450-2	10,200	10/20
7 x ¼ x ¾	051125-87451-9	8,500	10/20
9 x ¼ x ¾	051125-87452-6	6,650	10/20

### 3M™ Silver Depressed Center Grinding Wheel – T27 Quick Change

Diameter x Thickness x Arbor Hole (inches)	UPC	Max. RPM	Quantity (Inner/Case)
4½ x ¼ x ¾-11	051125-87397-0	13,300	10/20
5 x ¼ x ¾-11	051125-87446-5	12,250	10/20
6 x ¼ x ¾-11	051125-87447-2	10,200	10/20
7 x ¼ x ¾-11	051125-87448-9	8,500	10/20
9 x ¼ x ¾-11	051125-87449-6	6,650	10/20



## What's the bottom line?

If you're looking to optimize productivity, and see the value it brings to shop savings, choose **Cubitron II Depressed Center Grinding Wheels**.

- ✓ Highest productivity
- ✓ Lowest overall production cost

If your concerns are more cost-driven, try **3M Silver Depressed Center Grinding Wheels** as an alternative with excellent performance.

- ✓ High productivity
- ✓ Lowest overall abrasive spend

## 3M™ Cubitron™ II Fibre Discs 982CX Pro

The best just got even better.

Featuring re-engineered 3M Precision-Shaped Grain and a redesigned construction, these fibre discs cut **33% faster** and last even longer than our legendary 3M™ Cubitron™ II Fibre Discs 982C. Plus, they cut with less pressure to help reduce operator fatigue. Cubitron II Fibre Discs 982CX Pro are ideal for aggressive medium and high-pressure grinding on carbon steel. Plus, they are contaminant-free and INOX compliant!

### 3M™ Cubitron™ II Fibre Disc 982CX Pro, Grade 36+

UPC	Diameter (inches)	Max. RPM	Quantity (Inner/Case)
06-38060-83330-8	4 × 5/8	15,000	25/100
06-38060-83328-5	4 × 7/8	15,000	25/100
06-38060-83313-1	4 1/2 × 7/8	13,300	25/100
06-38060-83314-8	5 × 7/8	12,000	25/100
06-38060-83327-8	6 × 7/8	10,000	25/100
06-38060-83315-5	7 × 7/8	8,600	25/100
06-38060-83316-2	9 1/8 × 7/8	6,600	25/100

### TN Quick Change

UPC	Diameter (inches)	Max. RPM	Quantity (Inner/Case)
06-38060-83320-9	4 1/2 × 5/8-11	13,300	25/100
06-38060-83317-9	5 × 5/8-11	12,000	25/100
06-38060-83331-5	7 × 5/8-11	8,600	25/100

### GL Quick Change

UPC	Diameter (inches)	Max. RPM	Quantity (Inner/Case)
06-38060-83329-2	4 1/2 × 5/8-11	13,300	25/100
06-38060-83318-6	5 × 5/8-11	12,000	25/100
06-38060-83319-3	7 × 5/8-11	8,600	25/100



TN Quick Change



GL Quick Change

### ► Tech Tip

Unwanted elements like iron can become embedded in a weld or substrate and weaken the finished product. 3M™ Cubitron™ II Fibre Discs 982CX Pro are contaminant-free and INOX compliant – which is especially important for some shipbuilding and stainless steel vessels, and other applications where weld integrity is critical.

# 3M™ Cubitron™ II Fibre Discs 982CX Pro

## Experience the power of re-engineered 3M Precision-Shaped Grain

We didn't reinvent the wheel – but we re-engineered our legendary precision-shaped grain to shift productivity into an even higher gear. The new **982CX Pro fibre disc** is designed to outperform and outlast original 3M™ Cubitron™ II Fibre Discs, giving you more power than ever before.

### Cut Rate Comparison (g/Cycle)

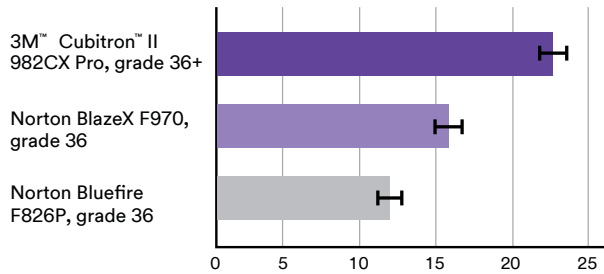

**45%** Faster cut-rate than Norton BlazeX F970, grade 36

**90%** Faster cut-rate than Norton Bluefire F826P, grade 36

### Material Removed (g)

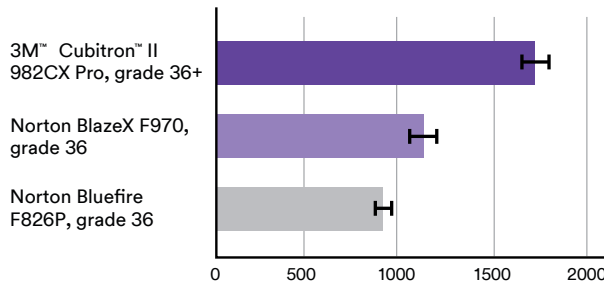

**45%** More material removed than Norton BlazeX F970, grade 36

**89%** More material removed than Norton Bluefire F826P, grade 36

Results are based on an automated, 16 minute grinding test on 1018 steel using 7 inch 3M™ Cubitron™ II Fibre Discs 982CX Pro, grade 36+ and 7 inch competitive fibre discs, grade 36 with a 3M™ Disc Pad Face Plate Ribbed 80514 on a servo motor. Each cycle consists of 13 seconds of grinding. Error bars represent the 95% confidence interval for the mean.

Conventional ceramic abrasive grain tends to “plow” through metal, causing heat to build up in the workpiece and the abrasive, resulting in a slower cut and shorter abrasive life.

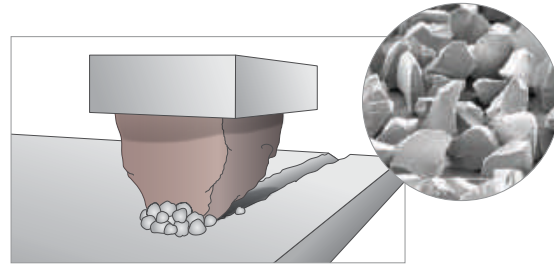

Conventional Ceramic Abrasive

3M pioneered the first precision-shaped grain using 3M microreplication technology to form consistent sharp peaks that easily “slice” through metal—cutting cooler, faster and lasting longer than conventional abrasive grain.

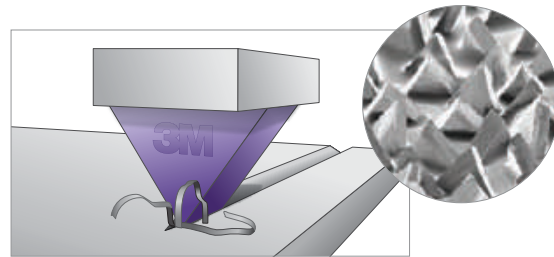

3M Precision-Shaped Grain

**And now, we've done it again.**

### ► Tech Tip

*To optimize abrasive life and productivity, use the new 3M™ Pneumatic Angle Grinder or Pneumatic Sander (page 30) with the new, one-piece 3M™ Disc Back-up Pad, Ribbed, Extra Hard.*



# Premium Series

## 3M™ Cubitron™ II Fibre Discs

### Legendary power and performance

Cubitron II Fibre Discs are engineered to cut faster, cooler and with less grinding pressure than conventional abrasives. And they are long lasting for increased productivity!

Choose **Cubitron II Fibre Discs 987C** for cool cutting on stainless steel, high-nickel alloys and superalloys. For carbon steel applications, try our **Cubitron II Fibre Discs 982C**.

#### 3M™ Cubitron™ II Fibre Disc 982C for carbon steel

Diameter* (inches)	Grade	UPC (051141-)	Max. RPM	Min/Case
4½ × ⅞	36+	27400-3	13,300	25/100
	60+	27631-1	13,300	25/100
	80+	27635-9	13,300	25/100
4½ × TN**	36+	27425-6	13,300	25/100
	60+	27639-7	13,300	25/100
	80+	27642-7	13,300	25/100
5 × ⅞	36+	27401-0	12,000	25/100
	60+	27632-8	12,000	25/100
	80+	27636-6	12,000	25/100
5 × TN**	36+	27404-1	12,000	25/100
	60+	27640-3	12,000	25/100
	80+	27643-4	12,000	25/100
5 × GL**	36+	27406-5	12,000	25/100
	36+	27402-7	8,600	25/100
	60+	27633-5	8,600	25/100
7 × ⅞	80+	27637-3	8,600	25/100
	36+	27405-8	8,600	25/100
	60+	27641-0	8,600	25/100
7 × TN**	80+	27644-1	8,600	25/100
	36+	27407-2	8,600	25/100
	60+	27403-4	6,600	25/100
7 × GL**	60+	27634-2	6,600	25/100
	80+	27638-0	6,600	25/100
	9⅞ × ⅞			

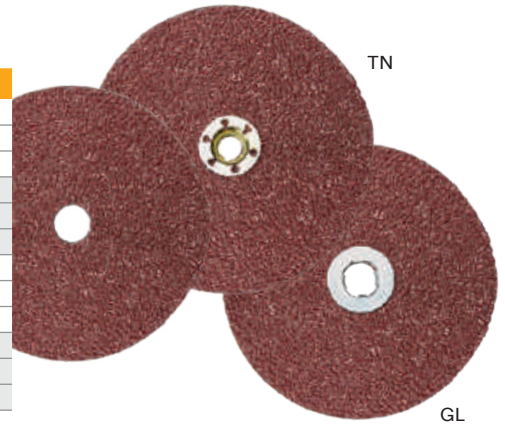

#### ▶ Tech Tip

3M™ Disc Back-up Pads, Ribbed, Extra Hard provide the firm support required for coarse grade fibre discs in medium to heavy grinding applications. This helps deliver a consistent cut and long abrasive life.

#### 3M™ Cubitron™ II Fibre Disc 987C for stainless steel and other heat-sensitive alloys

Diameter* (inches)	Grade	UPC (051141-)	Max. RPM	Min/Case
4½ × ⅞	36+	27447-8	13,300	25/100
	60+	27653-3	13,300	25/100
	80+	27657-1	13,300	25/100
4½ × TN**	36+	27469-0	13,300	25/100
	60+	27661-8	13,300	25/100
	80+	27664-9	13,300	25/100
5 × ⅞	36+	27448-5	12,000	25/100
	60+	27654-0	12,000	25/100
	80+	27658-8	12,000	25/100
5 × TN**	36+	27467-6	12,000	25/100
	60+	27662-5	12,000	25/100
	80+	27665-6	12,000	25/100
7 × ⅞	36+	27449-2	8,600	25/100
	60+	27655-7	8,600	25/100
	80+	27659-5	8,600	25/100
7 × TN**	36+	27468-3	8,600	25/100
	60+	27663-2	8,600	25/100
	80+	27666-3	8,600	25/100
9⅞ × ⅞	36+	27450-8	6,600	25/100
	60+	27656-4	6,600	25/100
	80+	27660-1	6,600	25/100

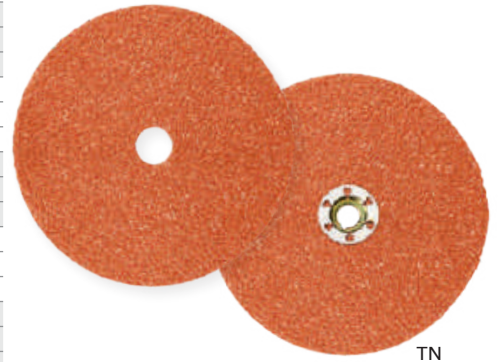

\*Other sizes available upon request. \*\*Quick Change Tinneman Nut Attachment

## 3M™ Fibre Discs 782C and 787C

**An unbeatable combination of performance and value.**

3M™ Fibre Discs 782C and 787C represent a new class of high-performance, right-angle abrasives – powered by the legendary speed and long life of 3M Precision-Shaped Grain. They are an ideal choice for applications like weld removal, beveling, edge chamfering and more – offering a faster cut and longer life than alumina zirconia (AZ) and conventional ceramic abrasives.

**3M™ Fibre Disc 782C** is an ideal choice for carbon steel. **3M™ Fibre Disc 787C** is optimized for stainless steel and non-ferrous metals like aluminum.

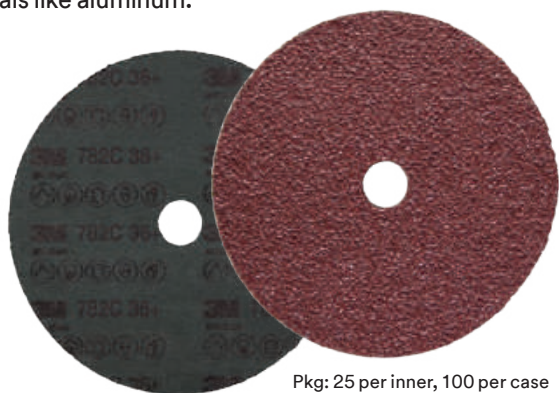

Pkg: 25 per inner, 100 per case

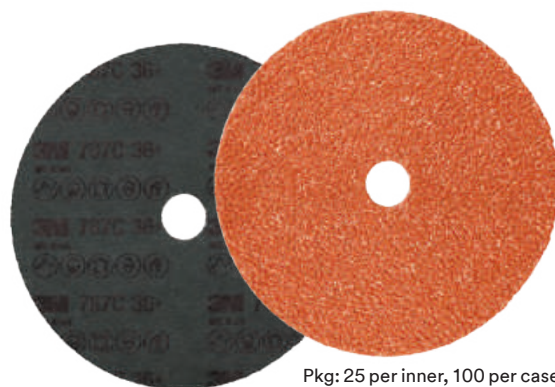

Pkg: 25 per inner, 100 per case

### 3M™ Fibre Disc 782C for carbon steel

Diameter* (inches)	Grade	UPC (76308-)	Max. RPM
4½ × 7⁄₈	36+	89589-1	13,300
	60+	89598-3	13,300
	80+	89607-2	13,300
5 × 7⁄₈	36+	89590-7	12,000
	60+	89599-0	12,000
	80+	89608-9	12,000
7 × 7⁄₈	36+	89591-4	8,600
	60+	89600-3	8,600
	80+	89609-6	8,600
9½ × 7⁄₈	36+	89592-1	6,600
	60+	89601-0	6,600
	80+	89610-2	6,600
TN Quick Change			
4½ × 5⁄₈-11**	36+	89595-2	13,300
	60+	89604-1	13,300
	80+	89613-3	13,300
5 × 5⁄₈-11**	36+	89596-9	12,000
	60+	89605-8	12,000
	80+	89614-0	12,000
7 × 5⁄₈-11**	36+	89597-6	8,600
	60+	89606-5	8,600
	80+	89615-7	8,600

### 3M™ Fibre Disc 787C for stainless steel non-ferrous metals

Diameter* (inches)	Grade	UPC (76308-)	Max. RPM
4½ × 7⁄₈	36+	89627-0	13,300
	60+	89636-2	13,300
	80+	89645-4	13,300
	120+	89654-6	13,300
5 × 7⁄₈	36+	89628-7	12,000
	60+	89637-9	12,000
	80+	89646-1	12,000
	120+	89655-3	12,000
7 × 7⁄₈	36+	89629-4	8,600
	60+	89638-6	8,600
	80+	89647-8	8,600
	120+	89656-0	8,600
9½ × 7⁄₈	36+	89630-0	6,600
	60+	89639-3	6,600
	80+	89648-5	6,600
	120+	89657-7	6,600
TN Quick Change			
4½ × 5⁄₈-11**	36+	89633-1	13,000
	60+	89642-3	13,000
	80+	89651-5	13,000
	120+	89658-4	13,000
5 × 5⁄₈-11**	36+	89634-8	12,000
	60+	89643-0	12,000
	80+	89652-2	12,000
	120+	89659-1	12,000
7 × 5⁄₈-11**	36+	89635-5	8,600
	60+	89644-7	8,600
	80+	89653-9	8,600
	120+	89660-7	8,600

\*Other sizes available upon request. \*\*Quick Change Tinneman Nut Attachment

# Premium Series

## 3M™ Cubitron™ II Flap Discs

The one-step alternative to bonded wheels and fibre discs.

3M™ Cubitron™ II Flap Discs let you breeze through a wide range of tough jobs around the shop, including grinding, weld removal, deburring and more. These smooth-running wheels are designed to cut with less pressure. They include a grinding aid to help maintain cutting efficiency on heat-sensitive metals. And, because they are made with 3M Precision-Shaped Grain, they keep on cutting – long after other flap discs have called it quits!

### 3M™ Cubitron™ II Flap Discs 967A

Constructed with a poly-cotton backing that exposes fresh mineral as they wear, for a fast, forgiving cut. Perform well on many common applications, offering a great balance of fast cut and long life.



## Product availability

### 3M™ Cubitron™ II Flap Discs 967A

TYPE 27					TYPE 29				
UPC (051141-) unless otherwise specified	Grade	Dia. × Ctr. Hole (inches)	Max. RPM (MOS)	Qty/Case	UPC (051141-) unless otherwise specified	Grade	Dia. × Ctr. Hole (inches)	Max. RPM (MOS)	Qty/Case
55602-4	40+				55614-7	40+			
55603-1	60+	4½ × ⅝-11	13,300	10	55615-4	60+	4 × ⅜-24	15,000	10
55604-8	80+				55616-1	80+			
55632-1	40+				55617-8	40+			
55633-8	60+	4½ × ⅝-11 GIANT	13,300	10	55618-5	60+	4 × ⅝	15,000	10
55634-5	80+				55619-2	80+			
55605-5	40+				55620-8	40+			
55606-2	60+	4½ × ⅞	13,300	10	55621-5	60+	4½ × ⅝-11	13,300	10
55607-9	80+				55622-2	80+			
55635-2	40+				55644-4	40+			
55636-9	60+	4½ × ⅞ GIANT	13,300	10	55645-1	60+	4½ × ⅝-11 GIANT	13,300	10
55637-6	80+				55646-8	80+			
86715-3	40+				55623-9	40+			
051125-86718-4	60+	5 × ⅞	12,000	10	55624-6	60+	4½ × ⅞	13,300	10
051125-86719-1	80+				55625-3	80+			
55608-6	40+				55647-5	40+			
55609-3	60+	7 × ⅝-11	8,600	5	55648-2	60+	4½ × ⅞ GIANT	13,300	10
55610-9	80+				55649-9	80+			
55638-3	40+				051125-86716-0	40+			
55639-0	60+	7 × ⅝-11 GIANT	8,600	5	051125-86717-7	60+	5 × ⅞	12,000	10
55640-6	80+				051125-86720-7	80+			
55611-6	40+				55626-0	40+			
55612-3	60+	7 × ⅞	8,600	5	55627-7	60+	7 × ⅝-11	8,600	5
55613-0	80+				55628-4	80+			
55641-3	40+				55650-5	40+			
55642-0	60+	7 × ⅞ GIANT	8,600	5	55651-2	60+	7 × ⅝-11 GIANT	8,600	5
55643-7	80+				55652-9	80+			
					55629-1	40+			
					55630-7	60+	7 × ⅞	8,600	5
					55631-4	80+			
					55653-6	40+			
					55654-3	60+	7 × ⅞ GIANT	8,600	5
					55655-0	80+			

More material.  
Longer life.

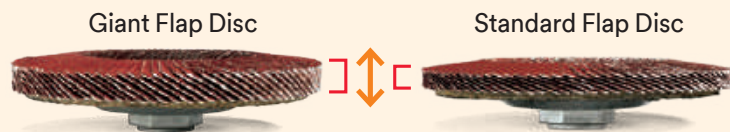

Need more cutting power? Go GIANT!

Our Giant flap discs are 25% thicker, for an aggressive cut with added durability and longer life.

For more information, call 1-866-279-1235 to speak with a 3M abrasive expert.



**3M™ Cubitron™ II Flap Discs 969F**  
 Featuring a tough polyester backing to hold up under demanding applications like heavy grinding, edge deburring and beveling.



Get top results with  
**3M™ Cubitron™ II Flap Discs.**



**Medium duty**



**Heavy duty**

- Weld removal
- Scale removal
- Oxide removal
- Surface prep
- Metal dimensioning
- Blending

- Light cleaning
- Beveling
- Edge deburring
- Aggressive weld removal

## Product availability

### 3M™ Cubitron™ II Flap Discs 969F

TYPE 27					TYPE 29				
UPC (076308-) unless otherwise specified	Grade	Dia. x Ctr. Hole (inches)	Max. RPM (MOS)	Qty/Case	UPC (076308-) unless otherwise specified	Grade	Dia. x Ctr. Hole (inches)	Max. RPM (MOS)	Qty/Case
64373-7	40+	4½ × ⅝-11	13,300	10	64385-0	40+	4 × ¾-24	15,000	10
64374-4	60+				64386-7	60+			
64375-1	80+				64387-4	80+			
64403-1	40+	4½ × ⅝-11 GIANT	13,300	10	64388-1	40+	4 × ⅝	15,000	10
64404-8	60+				64389-8	60+			
64405-5	80+				64390-4	80+			
64376-8	40+	4½ × ⅞	13,300	10	64391-1	40+	4½ × ⅝-11	13,300	10
64377-5	60+				64392-8	60+			
64378-2	80+				64393-5	80+			
64406-2	40+	4½ × ⅞ GIANT	13,300	10	64415-4	40+	4½ × ⅝-11 GIANT	13,300	10
64407-9	60+				64416-1	60+			
64408-6	80+				64417-8	80+			
89844-1	40+	5 × ⅞	12,000	10	64394-2	40+	4½ × ⅞	13,300	10
89847-2	60+				64395-9	60+			
89848-9	80+				64396-6	80+			
64379-9	40+	7 × ⅞-11	8,600	5	64418-5	40+	4½ × ⅞ GIANT	13,300	10
64380-5	60+				64419-2	60+			
64381-2	80+				64420-8	80+			
64409-3	40+	7 × ⅞-11 GIANT	8,600	5	89845-8	40+	5 × ⅞	12,000	10
64410-9	60+				89846-5	60+			
64411-6	80+				89849-6	80+			
64382-9	40+	7 × ⅞	8,600	5	64397-3	40+	7 × ⅞-11	8,600	5
64383-6	60+				64398-0	60+			
64384-3	80+				64399-7	80+			
64412-3	40+	7 × ⅞ GIANT	8,600	5	64421-5	40+	7 × ⅞-11 GIANT	8,600	5
64413-0	60+				64422-2	60+			
64414-7	80+				64423-9	80+			
		7 × ⅞ GIANT	8,600	5	64400-0	40+	7 × ⅞	8,600	5
					64401-7	60+			
					64402-4	80+			
					64424-6	40+	7 × ⅞ GIANT	8,600	5
					64425-3	60+			
					64426-0	80+			

## ► Tech Tip

*3M™ Cubitron™ II Flap Discs will often produce a finish equivalent to the next-finer grade of a fibre disc (i.e., a 60-grit flap disc will usually leave a finish similar to an 80-grit fibre disc) – saving you time and finishing steps!*

# Advanced Series

## 3M™ Flap Discs 769F

Everyday value.  
Exceptional performance.

These value-priced discs harness the power of 3M Precision-Shaped Grain **and** the versatility of flap discs, all at a price that's affordable for everyday use. Get dependable performance with fewer disc changes – and get more work done over the life of your disc.



**Improved plastic hub is both rugged and lightweight!**

### Product availability

#### 3M™ Flap Discs 769F

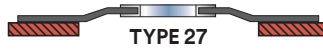

UPC (0-06-38060-)	Grade	Diameter x Center Hole (inches)	Max. RPM (MOS)	Qty/Case
05903-6	40+	4.5 x 7/8	13,300	10
05904-3	60+			
05905-0	80+			
05924-1	120+	5 x 7/8	12,000	10
05915-9	40+			
05918-0	60+			
05919-7	80+			
05928-9	120+	7 x 7/8	8,600	5
05909-8	40+			
05910-4	60+			
05911-1	80+			
05926-5	120+			

UPC (0-06-38060-)	Grade	Diameter x Center Hole (inches)	Max. RPM (MOS)	Qty/Case
05906-7	40+	4.5 x 7/8	13,300	10
05907-4	60+			
05908-1	80+			
05925-8	120+	5 x 7/8	12,000	10
05916-6	40+			
05917-3	60+			
05920-3	80+			
05929-6	120+	7 x 7/8	8,600	5
05912-8	40+			
05913-5	60+			
05914-2	80+			
05927-2	120+			

#### Quick Change Hub Attachment

UPC (0-06-38060-)	Grade	Diameter x Center Hole (inches)	Max. RPM (MOS)	Qty/Case
88512-3	40+	4.5 x 5/8-11	13,300	10
88511-6	60+			
88510-9	80+			
88509-3	120+	5 x 5/8-11	12,000	10
88505-5	40+			
88504-8	60+			
88503-1	80+			
88502-4	120+	7 x 5/8-11	8,600	5
05940-1	40+			
05941-8	60+			
05942-5	80+			

UPC (0-06-38060-)	Grade	Diameter x Center Hole (inches)	Max. RPM (MOS)	Qty/Case
88513-0	40+	4.5 x 5/8-11	13,300	10
88508-6	60+			
88507-9	80+			
88506-2	120+	5 x 5/8-11	12,000	10
88501-7	40+			
88500-0	60+			
88499-7	80+			
88498-0	120+	7 x 5/8-11	8,600	5
05943-2	40+			
05944-9	60+			
05945-6	80+			

### Fibre Discs vs. Depressed Center Grinding Wheel vs. Flap Disc

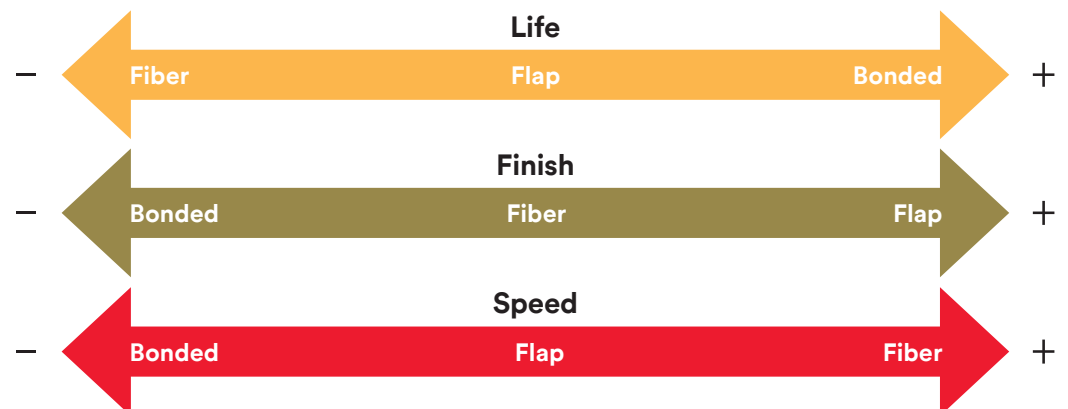

## Choose the right flap disc for your job.

### A word about wear.

The life and cut of a flap disc is determined by how quickly the backing wears away to expose new mineral. If it wears too quickly, it can significantly shorten the disc life. But if it doesn't wear properly, the disc might stop cutting altogether. The backing in 3M™ Flap Discs 769F is designed to wear just the right amount to provide consistent cut over a wide range of medium- and heavy-duty applications. Combined with the power of 3M Precision-Shaped Grain, that helps 3M™ Flap Discs 769F outperform the competition – at a value price!



For even faster cut and longer life, try 3M™ Cubitron™ II Flap Discs 967A and 969F. See pages 16-17.

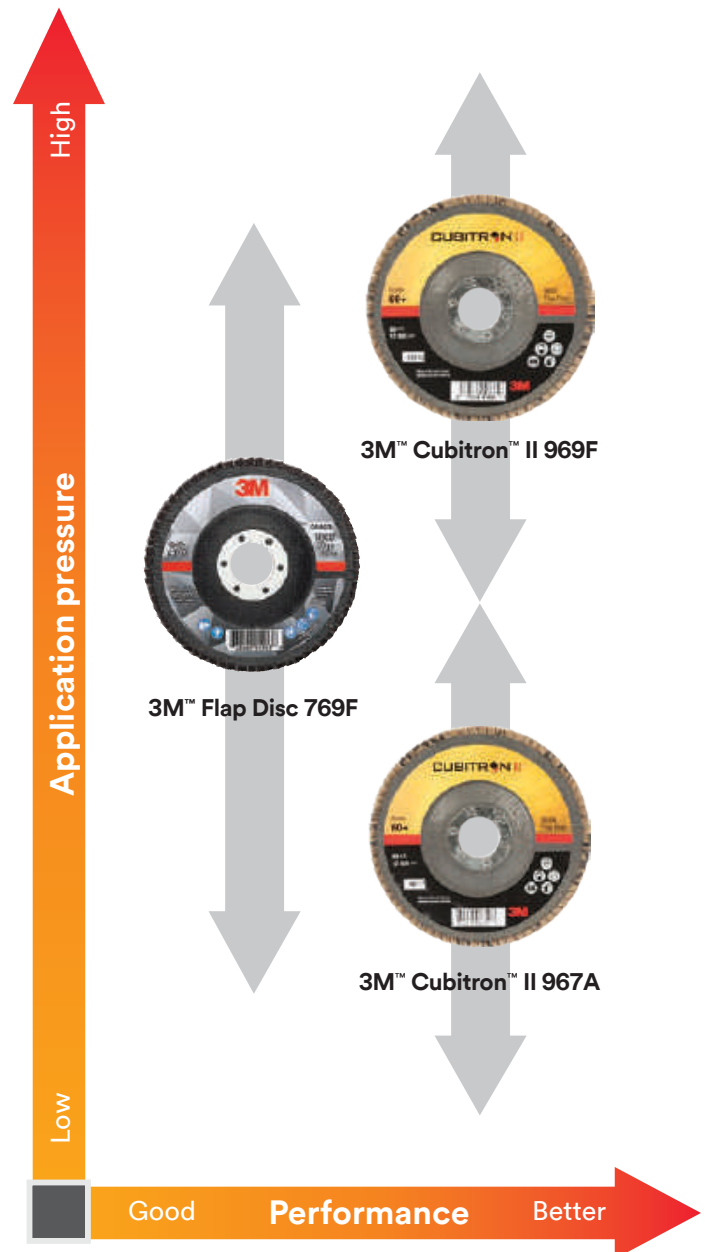

#### Medium duty

- Weld removal
- Scale removal
- Oxide removal
- Surface prep
- Blending
- Light cleaning

#### Heavy duty

- Beveling
- Edge deburring
- Aggressive weld removal

# Premium Series

## 3M™ Cubitron™ II Cut & Grind Wheels

### Cut. Grind. Done.

These versatile wheels are designed to be used both as a depressed center grinding wheel and as a cut-off wheel – making them ideal for cutting, grinding, gouging and more. After 10 minutes of use, they nearly doubled the output of our closest competitor while removing nearly 2x the material.

#### 3M™ Cubitron™ II Cut & Grind Wheels – T27

Diameter x Thickness x Arbor Hole (inches)	UPC	Max. RPM	Quantity (Inner/Case)
4 x 1/8 x 3/8	4046719-82276-8	15,300	10/20
4 x 1/8 x 3/8	4046719-82277-5	15,300	10/20
5 x 1/8 x 3/8	4046719-82278-2	12,250	10/20
4 1/2 x 1/8 x 3/8	4046719-82279-9	13,300	10/20
6 x 1/8 x 3/8	051141-28758-4	10,200	10/20
7 x 1/8 x 3/8	051141-28760-7	8,500	10/20
9 x 1/8 x 3/8	051141-28761-4	6,650	10/20

#### 3M™ Cubitron™ II Cut & Grind Wheels – T27 Quick Change

Diameter x Thickness x Arbor Hole (inches)	UPC	Max. RPM	Quantity (Inner/Case)
4 1/2 x 1/8 x 3/8-11	051141-28762-1	13,300	10/20
5 x 1/8 x 3/8-11	051141-28763-8	12,250	10/20
6 x 1/8 x 3/8-11	051141-28764-5	10,200	10/20
7 x 1/8 x 3/8-11	051141-28765-2	8,500	10/20
9 x 1/8 x 3/8-11	051141-28766-9	6,650	10/20



#### 3M™ Cubitron™ II Cut & Grind Wheels Cut Faster! After 10 min., nearly double the output of our closest competitor

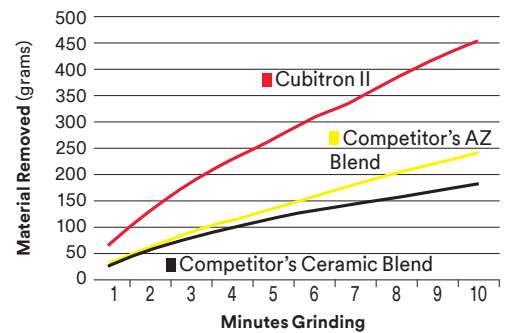

#### 3M™ Cubitron™ II Cut & Grind Wheels Last Longer! Removes nearly 2x the material, compared to our closest competitor

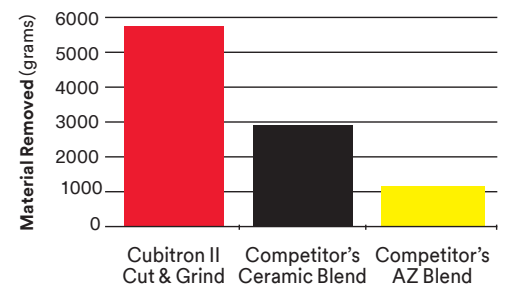

## 3M™ Cut & Grind Wheels

### Value and versatility.

The newest addition to our Advanced Series of abrasives, 3M Cut & Grind Wheels are designed for use as both depressed center grinding wheels and cut-off wheels, so you can get more done for your dollar.

3M™ Cut & Grind Wheel (638060-)	Type	Diameter x Center Hole (inches)	Maximum RPM	Maximum Speed (m/s)	Discs Per Box/Case
06459-7	T1	4 × 1/8 × 3/8	15,300	80	10/20
06460-3	T27	4 × 1/8 × 3/8	15,300	80	10/20
06461-0	T27	4 × 1/8 × 3/8	15,300	80	10/20
06462-7	T27	4 1/2 × 1/8 × 7/8	13,300	80	10/20
06463-4	T27	5 × 1/8 × 7/8	12,500	80	10/20
06469-6	T27	6 × 1/8 × 7/8	10,200	80	10/20
06470-2	T27	7 × 1/8 × 7/8	8,500	80	10/20
06471-9	T27	9 × 1/8 × 7/8	6,650	80	10/20

### Quick Change Attachment

06464-1	T27	4 1/2 × 1/8 × 5/8-11	13,300	80	10/20
06465-8	T27	5 × 1/8 × 5/8-11	12,500	80	10/20
06466-5	T27	6 × 1/8 × 5/8-11	10,200	80	10/20
06467-2	T27	7 × 1/8 × 5/8-11	8,500	80	10/20
06468-9	T27	9 × 1/8 × 5/8-11	6,650	80	10/20

### Cut & Grind Wheel Wear Comparison

3M™ Cut & Grind wheels wear less and last longer than the competition!

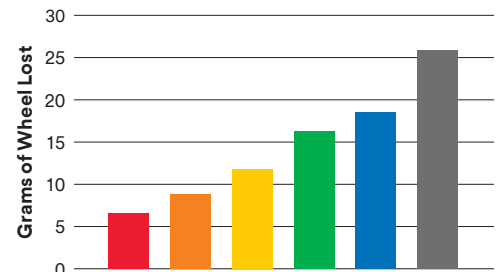

Internal 3M testing - wheels were tested robotically for 10 min. on 1018 carbon steel

- 3M™ Cut & Grind
- Flexovit Metalhog
- Dewalt XP Extended Performance (Pipeline)
- Pferd SG-Elastic Pipeline
- Norton Blue Fire
- Sait Z Tech Pipeline



## 3M™ Cubitron™ II Cut-Off Wheels

### Cut to the chase.

Cubitron II Cut-Off Wheels are designed to provide high cut rates on all types of ferrous metals, stainless steels, alloy steels and cast iron. They offer long life to help reduce cost. Plus, their fast, cool cutting action helps make your job easier!



### Wheel life

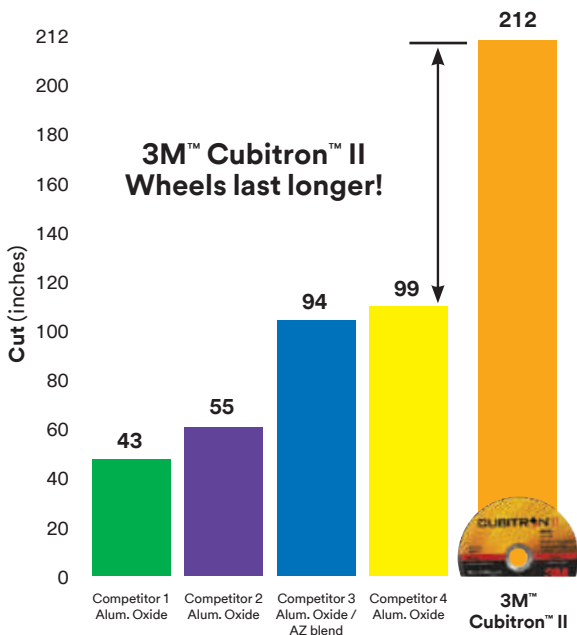

Internal 3M testing on 304L stainless steel sheet (11 gauge) using a 13 amp electric tool.

### 3M™ Cubitron™ II Cut-Off Wheel – T1

Diameter × Thickness × Arbor Hole (inches)	UPC	Max. RPM	Quantity (Inner/Case)
3 × .035 × ¼	051115-66513-4	25,465	25/50
3 × .035 × ⅜	051115-66514-1	25,465	25/50
3 × .06 × ⅝	051115-66516-5	25,465	25/50
4 × .035 × ⅜	051115-66518-9	19,100	25/50
4 × .06 × ⅝	051115-66520-2	19,100	25/50
4 × .125 × ⅝	051115-66524-0	19,100	25/50
4 ½ × .040 × ⅞	051125-86929-4	13,300	25/50
4 ½ × .045 × ⅞	051115-66525-7	13,300	25/50
5 × .040 × ⅞	051125-86930-0	12,250	25/50
5 × .045 × ⅞	051115-66526-4	12,250	25/50
6 × .045 × ⅞	051115-66527-1	10,200	25/50
7 × .045 × ⅞	051115-66528-8	8,500	25/50

### 3M™ Cubitron™ II Cut-Off Wheel – T27

Diameter × Thickness × Arbor Hole (inches)	UPC	Max. RPM	Quantity (Inner/Case)
4 ½ × .040 × ⅞	051125-86946-1	13,300	25/50
4 ½ × .045 × ⅞	051115-66531-8	13,300	25/50
4 ½ × .125 × ⅞	051115-66535-6	13,300	25/50
5 × .040 × ⅞	051125-86945-4	12,250	25/50
5 × .045 × ⅞	051115-66537-0	12,250	25/50
5 × .09 × ⅞	051115-66539-4	12,250	25/50
6 × .045 × ⅞	051115-66541-7	10,200	25/50
7 × .09 × ⅞	051115-66543-1	8,500	25/50

### 3M™ Cubitron™ II Cut-Off Wheel – T27 Quick Change

Diameter × Thickness × Arbor Hole (inches)	UPC	Max. RPM	Quantity (Inner/Case)
4 ½ × .045 × ⅞-11	051115-66530-1	13,300	25/50
4 ½ × .09 × ⅞-11	051115-66532-5	13,300	25/50
4 ½ × .125 × ⅞-11	051115-66534-9	13,300	25/50
6 × .045 × ⅞-11	051115-66540-0	10,200	25/50
7 × .09 × ⅞-11	051115-66542-4	8,500	25/50

## 3M™ Silver Cut-Off Wheels

### A cut above the ordinary.

3M™ Silver Cut-Off Wheels are premium performance wheels designed to be affordable for everyday use. Featuring 3M Precision-Shaped Grain technology, these innovative wheels deliver fast, smooth cutting action on all types of ferrous metals, stainless steels and alloy steels. Plus they last longer than aluminum oxide and alumina zirconia wheels. That means fewer wheel changes and more finished parts per wheel to help improve shop productivity and control your costs.

### 3M™ Silver Cut-Off Wheels – Type 1

Diameter × Thickness × Arbor Hole (inches)	UPC	Max. RPM	Quantity (Inner/Case)
3 × .035 × ¼	051125-87457-1	25,465	25/50
3 × .035 × ⅜	051125-87458-8	25,465	25/50
3 × .060 × ⅜	051125-87459-5	25,465	25/50
4 × .035 × ¼	051125-87460-1	19,100	25/50
4 × .035 × ⅜	051125-87461-8	19,100	25/50
4 × .060 × ⅜	051125-87462-5	19,100	25/50
4 × .125 × ⅜	051125-87657-5	19,100	25/50
4.5 × .040 × ⅞	051125-87464-9	13,300	25/50
4.5 × .045 × ⅞	051125-87465-6	13,300	25/50
5 × .045 × ⅞	051125-87467-0	12,250	25/50
6 × .045 × ⅞	051125-87469-4	10,200	25/50
7 × .045 × ⅞	051125-87471-7	8,500	25/50

### 3M™ Silver Cut-Off Wheels – Type 27

Diameter × Thickness × Arbor Hole (inches)	UPC	Max. RPM	Quantity (Inner/Case)
4.5 × .045 × ⅞	051125-87466-3	13,300	25/50
4.5 × .093 × ⅞	051125-87659-9	13,300	25/50
5 × .045 × ⅞	051125-87468-7	12,250	10/20
6 × .045 × ⅞	051125-87470-0	10,200	10/20





# QUALITY FINISHES. MADE EASY.

For over 50 years, metalworking professionals have trusted Scotch-Brite™ Abrasives for a wide range of cleaning, deburring and finishing applications on all types of metals. Scotch-Brite products feature an open-web construction that resists loading.

Scotch-Brite products help you improve surfaces without significantly changing the shape or dimension of the workpiece.

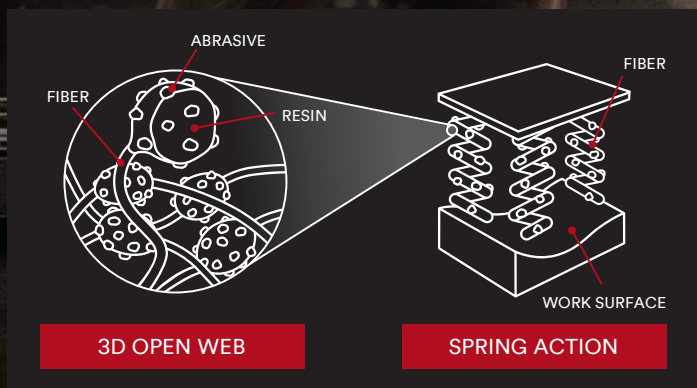





# CHOOSE THE RIGHT DISC FOR THE JOB.

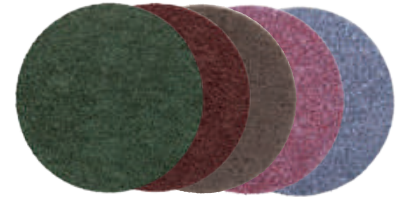
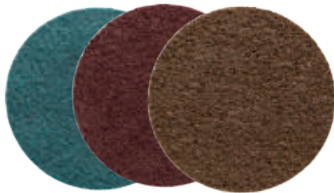

<b>LOAD RESISTANCE</b> Long lasting on flat parts and softer substrates	<b>MULTIPURPOSE</b> Multipurpose surface conditioning disc	<b>TOUGH</b> Long lasting on parts with sharp edges
<ul style="list-style-type: none"> <li>SC CRS</li> <li>SC MED</li> <li>SC VFN</li> </ul>	<ul style="list-style-type: none"> <li>Precision XCRS</li> <li>Precision CRS</li> <li>Precision MED</li> <li>Precision FIN</li> <li>Precision VFN</li> </ul>	<ul style="list-style-type: none"> <li>LGB SD</li> <li>LGB HD</li> <li>SE CRS</li> <li>SE MED</li> <li>SE FIN</li> </ul>

**Fast and Durable**  
Long lasting on parts with sharp edges

- Scotch-Brite™ Light Grinding & Blending Discs
- Scotch-Brite™ SE Surface Conditioning Discs
- Scotch-Brite™ Precision Surface Conditioning Disc, XCRS **NEW**

**Multi-Purpose**  
Surface conditioning disc. Load resistance.

- Scotch-Brite™ Precision Surface Conditioning Discs **NEW**
- Scotch-Brite™ SC Surface Conditioning Discs

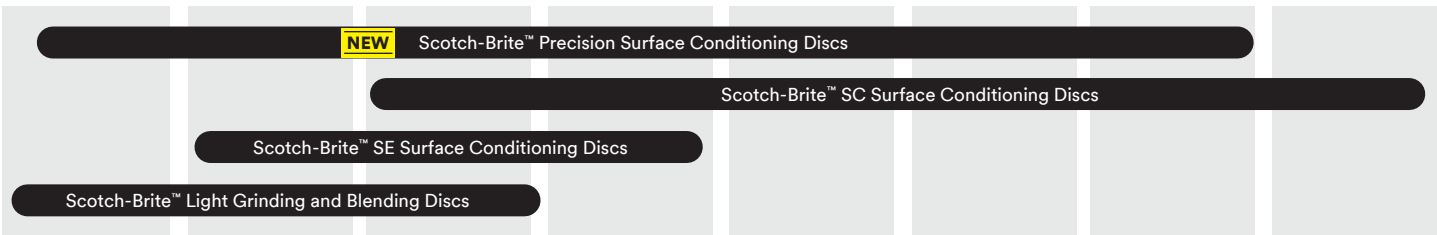



# MULTI-PURPOSE

## ► Tech Tip

Features 3M Precision-Shaped Grain for improved performance over traditional surface conditioning discs

## ► Tech Tip

Scotch-Brite™ PN-DH Discs medium grade discs finishes 3X as many aluminum parts than Norton Rapid Prep MED and SIA 6270 MED.

## ► Tech Tip

Suitable for aluminum and soft metals, carbon steel, stainless steel, and more. See page 36 for Accessories.

**NOTE:** Based on 3M internal testing: 3" discs were tested robotically on 6061 aluminum until the end of life (end of life is determined to be 50% of the averaged cut rate of the first three minutes) using a 3" 3M™ Hard Back-Up, part number: 45091. One part is equivalent to 20 g of material removed.

**NEW!** Scotch-Brite™ Universal Surface Conditioning Back-up Pad See page 33 for more information.



With Precision Shaped Grains

# SCOTCH-BRITE™ PRECISION SURFACE CONDITIONING DISCS

## FASTER TO THE FINISH

Meet the next advancement in surface conditioning technologies: Scotch-Brite™ Precision Surface Conditioning Discs. This new addition to the Scotch-Brite™ lineup promises the consistency you've come to expect with increased cutting speed and longer abrasive life. By combining two flagship 3M technologies — nonwoven fibre and ceramic 3M Precision-Shaped Grain — you can get the ideal finish, faster.

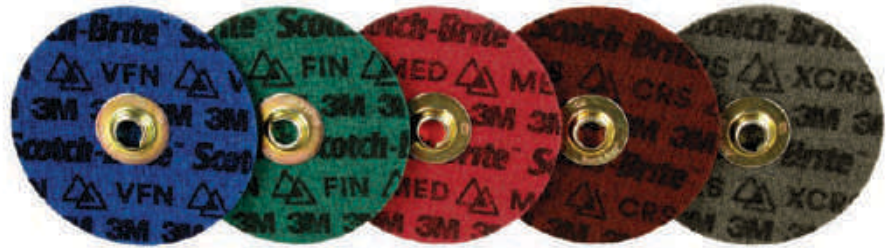

### Scotch-Brite™ Precision Surface Conditioning Disc – TN Quick Change

Diameter x Center Hole (inches)	UPC	Grade	Max. RPM	Qty/Case
4 ½ x ⅝-11*	61500-40847-3	Very Fine	13,330	50
	61500-40848-1	Fine		50
	61500-40849-9	Medium		50
	61500-40850-7	Coarse		50
	61500-40851-5	Extra Coarse		50
5 x ⅝-11*	61500-40852-3	Very Fine	12,000	50
	61500-40853-1	Fine		50
	61500-40854-9	Medium		50
	61500-40855-6	Coarse		50
7 x ⅝-11*	61500-40856-4	Extra Coarse	8,600	50
	61500-40857-2	Very Fine		25
	61500-40858-0	Fine		25
	61500-40859-8	Medium		25
	61500-40860-6	Coarse		25
	61500-40861-4	Extra Coarse		25

\*Quick-Change Tinnerman Nut (TN) Attachment

# MULTI-PURPOSE



## Scotch-Brite™ Precision Surface Conditioning Disc – Center Hole

Diameter × Center Hole (inches)	UPC	Grade	Max. RPM	Qty/Case
4 ½ × ⅞	61500-40770-7	Fine	13,300	50
	61500-40771-5	Medium		50
	61500-40772-3	Coarse		50
	61500-40773-1	Very Fine		50
	61500-40774-9	Extra Coarse		50
5 × ⅞	61500-40775-6	Fine	12,000	50
	61500-40776-4	Medium		50
	61500-40777-2	Coarse		50
	61500-40778-0	Very Fine		50
	61500-40779-8	Extra Coarse		50
7 × ⅞	61500-40781-4	Fine	8,600	25
	61500-40782-2	Medium		25
	61500-40783-0	Coarse		25
	61500-40780-6	Very Fine		25
	61500-40784-8	Extra Coarse		25

## Scotch-Brite™ Precision Surface Conditioning Disc – No Hole

Diameter × Center Hole (inches)	UPC	Grade	Max. RPM	Qty/Case
4 ½ × NH	61500-40795-4	Very Fine	13,300	50
	61500-40796-2	Fine		50
	61500-40797-0	Medium		50
	61500-40798-8	Coarse		50
	61500-40799-6	Extra Coarse		50
5 × NH	61500-40805-1	Very Fine	12,000	50
	61500-40806-9	Fine		50
	61500-40807-7	Medium		50
	61500-40808-5	Coarse		50
	61500-40809-3	Extra Coarse		50
6 × NH	61500-40810-1	Very Fine	10,000	25
	61500-40811-9	Fine		25
	61500-40812-7	Medium		25
	61500-40813-5	Coarse		25
	61500-40814-3	Extra Coarse		25
7 × NH	61500408150	Very Fine	8,600	50
	61500408168	Fine		50
	61500408176	Medium		50
	61500408184	Coarse		50
	61500408192	Extra Coarse		100



# LOAD RESISTANCE

## Tech Tip

Use for all your general surface conditioning needs. Scotch-Brite SC discs are durable enough for sharp edges, so they are ideal for use on rougher workpieces.

## ► Tech Tip

Use a Disc Pad Hub, Disc Pad Face Plate, and Disc Retainer Nut for ultimate disc performance. See page 36 for Accessories, including the NEW Scotch-Brite™ Universal Surface Conditioning Back-up Pad.

## SCOTCH-BRITE™ SURFACE CONDITIONING DISCS (SC)

### FOR GENERAL PURPOSE BLENDING

The ideal choice for general purpose surface conditioning, including finishing, cleaning and light deburring. Helps you achieve a consistent, paintable finish in fewer steps without damaging the base material. Durable open-web construction is designed to resist loading and greatly increase the life of the disc — so you don't have to change discs as often. Easily attaches to and removes from 3M™ Hook-and-Loop Backup Pads.

Diameter (inches)	UPC (048011-)	Grade	Color	Max. RPM	Qty/Case
4 ½	14101-5	A CRS	Brown	13,000	50
	14100-8	A MED	Maroon	13,000	50
	14099-5	A VFN	Blue	13,000	50
5	00750-2	A CRS	Brown	10,000	25
	00643-7	A MED	Maroon	10,000	25
	04303-6	A VFN	Blue	10,000	25
7	00751-9	A CRS	Brown	6,000	25
	00645-1	A MED	Maroon	6,000	25
	04305-0	A VFN	Blue	6,000	25

### Scotch-Brite™ Surface Conditioning (SC) Disc – Center Hole Disc

Diameter × Center Hole (inches)	UPC (048011-)	Grade	Color	Max. RPM	Qty/Case
4 ½ × ¾	60215-8	A CRS	Brown	13,300	50
	93146-3	A MED	Maroon	13,300	50
5 × ¾	16047-4	A CRS	Brown	12,000	50
	00644-4	A MED	Maroon	12,000	50
	18618-4	A VFN	Blue	12,000	50
7 × ¾	18626-9	A CRS	Brown	8,600	25
	18624-5	A VFN	Blue	8,600	25



# HEAVY DUTY



## SCOTCH-BRITE™ LIGHT GRINDING AND BLENDING DISCS

### FOR LIGHT GRINDING AND BLENDING

A durable disc constructed with 3M ceramic aluminum oxide blend abrasive grain, for an aggressive cut, long life and consistent finish. Resistant to edge wear. Ideal for light grinding applications to produce a burr-free and paintable finish.

#### Scotch-Brite™ Light Grinding & Blending Disc – TN Quick Change

Diameter x Center Hole (inches)	UPC (048011-)	Grade	Max. RPM	Qty/Case
4 ½ x ⅝-11*	60349-0	A CRS SD	13,000	50
	60348-3	A CRS HD	13,000	50
5 x ⅝-11*	60351-3	A CRS SD	12,000	50
	60350-6	A CRS HD	12,000	50
7 x ⅝-11*	60353-7	A CRS SD	8,600	25
	60352-0	A CRS HD	8,600	25

\*Quick Change Tinneman Nut Attachment

#### Scotch-Brite™ Light Grinding & Blending Disc – Center Hole Disc

Diameter x Center Hole (inches)	UPC (048011-)	Grade	Max. RPM	Qty/Case
4 ½ x ⅝	60333-9†	A CRS SD	10,000	50
	60332-2†	A CRS HD	10,000	50
5 x ⅝	60341-4	A CRS SD	10,000	50
	60336-0	A CRS HD	10,000	50
7 x ⅝	60344-5	A CRS SD	6,000	25
	60347-6	A CRS HD	6,000	25

†Made-to-Order

SD = Super Duty HD = Heavy Duty

#### ► Tech Tip

Use for light stock removal and aggressive blending operations.

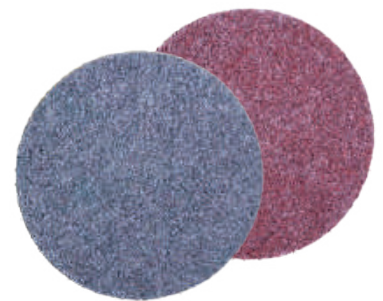

#### ► Tech Tip

##### 2-Step Weld Removal & Prep for Paint

- ✓ **STEP 1:**  
Remove the weld with 3M™ Cubitron™ II Fibre Disc 982CX Pro grade 36+
- ✓ **STEP 2:**  
Finish with Scotch-Brite LGB SD Disc
- ✓ **READY FOR PAINT**  
(>3 mil)

**NOTE:** For best results, use with red (extra hard) or black (hard) 3M™ Disc Face Plates.

#### ► Tech Tip

To optimize abrasive life and performance, use the convenient one-piece 3M™ Disc Back-up Pad, Ribbed, Extra Hard. See page 36 for Accessories.



# HEAVY DUTY

## ► Tech Tip

3M™ Hookit™ attachment system offers quick and easy disc change-out for multi-step finishing processes

## ► Tech Tip

Use a disc pad hub, disc pad face plate, and disc retainer but for ultimate disc performance. See page 36 for accessories.

## SCOTCH-BRITE™ SE SURFACE CONDITIONING DISC

Scotch-Brite™ SE Surface Conditioning Discs combine an aggressive, non-woven disc to perform heavy-duty deburring and finishing with the efficiency of a hook and loop attachment system. Our heavy-duty non-woven fiber construction conforms well to help preserve edges as well as irregular or contoured surfaces.

### Scotch-Brite™ SE Surface Conditioning Disc

Diameter (inches)	UPC (048011-)	Grade	Color	Max. RPM	Qty/Case
4 ½	18079-3	A CRS	Brown	13,000	50
	18476-0	A MED	Red	13,000	50
5	18080-9	A CRS	Brown	10,000	50
	18919-2*	A MED	Red	10,000	50
7	17866-0	A CRS	Brown	6,000	25
	18477-7	A MED	Red	6,000	25
	30003-0*	A FIN	Green	6,000	25

\*Made-to-Order

### Scotch-Brite™ SE Surface Conditioning Disc – Center Hole Disc

Diameter × Center Hole (inches)	UPC (048011-)	Grade	Color	Max. RPM	Qty/Case
4 ½ × ¾	33701-2	A CRS	Brown	13,000	50
5 × ¾	18947-5	A MED	Red	10,000	50
5 × ¾	18953-6	A CRS	Brown	10,000	50
7 × ¾	18951-2	A CRS	Brown	6,000	25



MED

CRS

FIN



# SURFACE PREPARATION

## SCOTCH-BRITE™ CLEAN AND STRIP XT PRO DISCS

### SPEED WITHOUT COMPROMISE.

Upgrade to the Scotch-Brite™ Clean and Strip XT Pro or XT Pro Extra Cut for rust and coating removal. Delivering the uncompromising results metalworkers have come to expect from Scotch-Brite™ Clean and Strip discs, with a faster speed rating, convenient quick-change threaded hub and extended life.

#### Scotch-Brite™ Clean & Strip XT Pro Disc

Diameter x Center Hole (inches)	UPC	Type	Grade	Max. RPM	Qty/Case
4 ½ x ⅝-11	0 06 38060 05574 8	Type 27 Quick Change	S XCS	13,300	10
4 ½ x ⅞	0 06 38060 05586 1	Type 27	S XCS	13,300	10
4 ½ x ⅝-11*	0 06 38060 05588 5	TN Quick Change	S XCS	13,300	10
7 x ⅞	0 06 38060 05587 8	Type 27	S XCS	8,600	5
7 x ⅝-11	0 00 76308 45481 4	Type 27 Quick Change	S XCS	8,600	5

#### Scotch-Brite™ Roloc™ Clean & Strip XT Pro Disc

3 x NH	0 06 38060 21540 1	TR	S XCS	15,000	10
--------	--------------------	----	-------	--------	----

#### Scotch-Brite™ Clean & Strip XT Pro Extra Cut Disc

Diameter x Center Hole (inches)	UPC	Type	Grade	Max. RPM	Qty/Case
4 ½ x ⅝-11	0 06 38060 21050 5	Type 27 Quick Change	A XCS	13,300	10
4 ½ x ⅞	0 06 38060 21032 1	Type 27	A XCS	13,300	10
4 ½ x ⅝-11*	0 06 38060 21037 6	TN Quick Change	A XCS	13,300	10
7 x ⅝-11	0 06 38060 21055 0	Type 27 Quick Change	A XCS	8,600	5
7 x ⅞	0 06 38060 21036 9	Type 27	A XCS	8,600	5

#### Scotch-Brite™ Roloc™ Clean & Strip XT Pro Extra Cut Disc

3 x NH	0 06 38060 21544 9	TR	A XCS	15,000	10
--------	--------------------	----	-------	--------	----

\*Quick Change Tinneman Nut Attachment

### Choose the disc that's right for you:

#### XT Pro

- Rust, paint, light mill scale removal
- Maintains workpiece shape
- Low sparking
- Ideal for surface prep
- Made with silicon carbide mineral



#### BOTH

- Rapid coating removal and surface prep
- Decreased chunking – extended life
- Highly conformable
- High speed rating
- Quick-change, spin-on thread



#### XT Pro Extra Cut

- Heavy rust and rust pit removal without leaving divots
- Thick paint and coating removal
- Weld refinement and removing weld discoloration
- Cuts to bare metal quickly
- Ideal for adhesion prep
- Made with aluminum oxide mineral



**3M** Science.  
Applied to Life.

# Abrasive Automation Within Arm's reach



Automating your abrasive process may be easier than you think – with the help of 3M's dedicated team of global application engineers, a robust network of system integrators and robotic partners, as well as abrasives that are ideal for robotic application. No matter where you are in your automation journey, our experts are here to help. Contact your 3M representative to learn more.

Learn more at [www.3M.com/Robotics](http://www.3M.com/Robotics)



Meet more 3M abrasive solutions:

**NEW!**

# Scotch-Brite™ Universal Surface Conditioning Back-up Pad

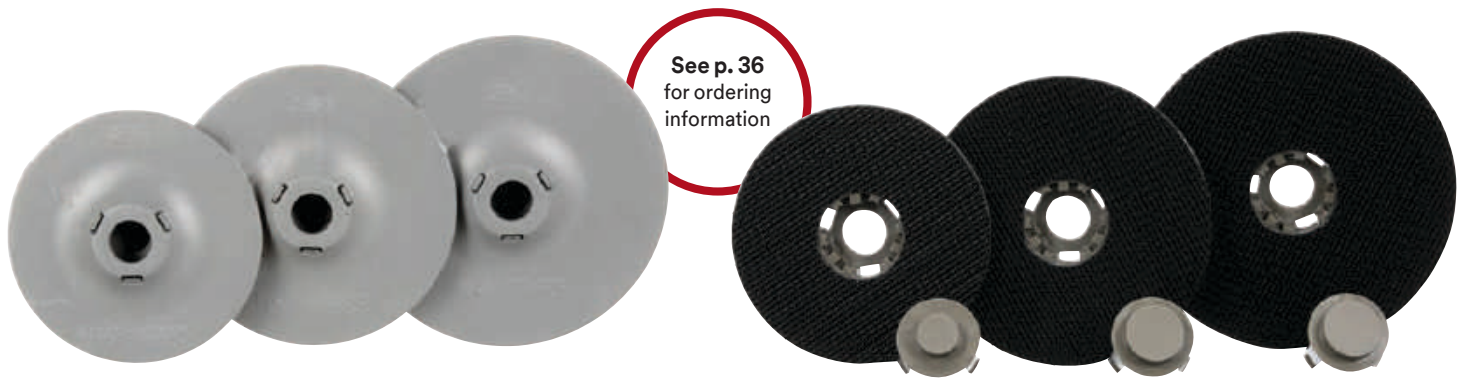

Featuring a secure, dual-lock attachment, a lower profile and a higher maximum operating speed. The Scotch-Brite Universal Back Up Pad can be run with Hook & Loop discs, No Hole discs and Center Hole discs. It offers improved centering, and comes packaged with everything you need for quick and easy tool attachment, including three attachment nuts (5/8-11, M14, M10) and an optional snap-in center post.

Product Name	UPC	Description	Max. RPM	For Use With	Min/Case
Scotch-Brite™ Universal Back Up Pad (multi-attachment)	89869	4 in. (100 mm)	15,000	Scotch-Brite™ Universal Surface Conditioning Back-Up Pad	10
	89871	5 in. (125 mm)	12,000		
	89870	4.5 in (115 mm)	13,300		

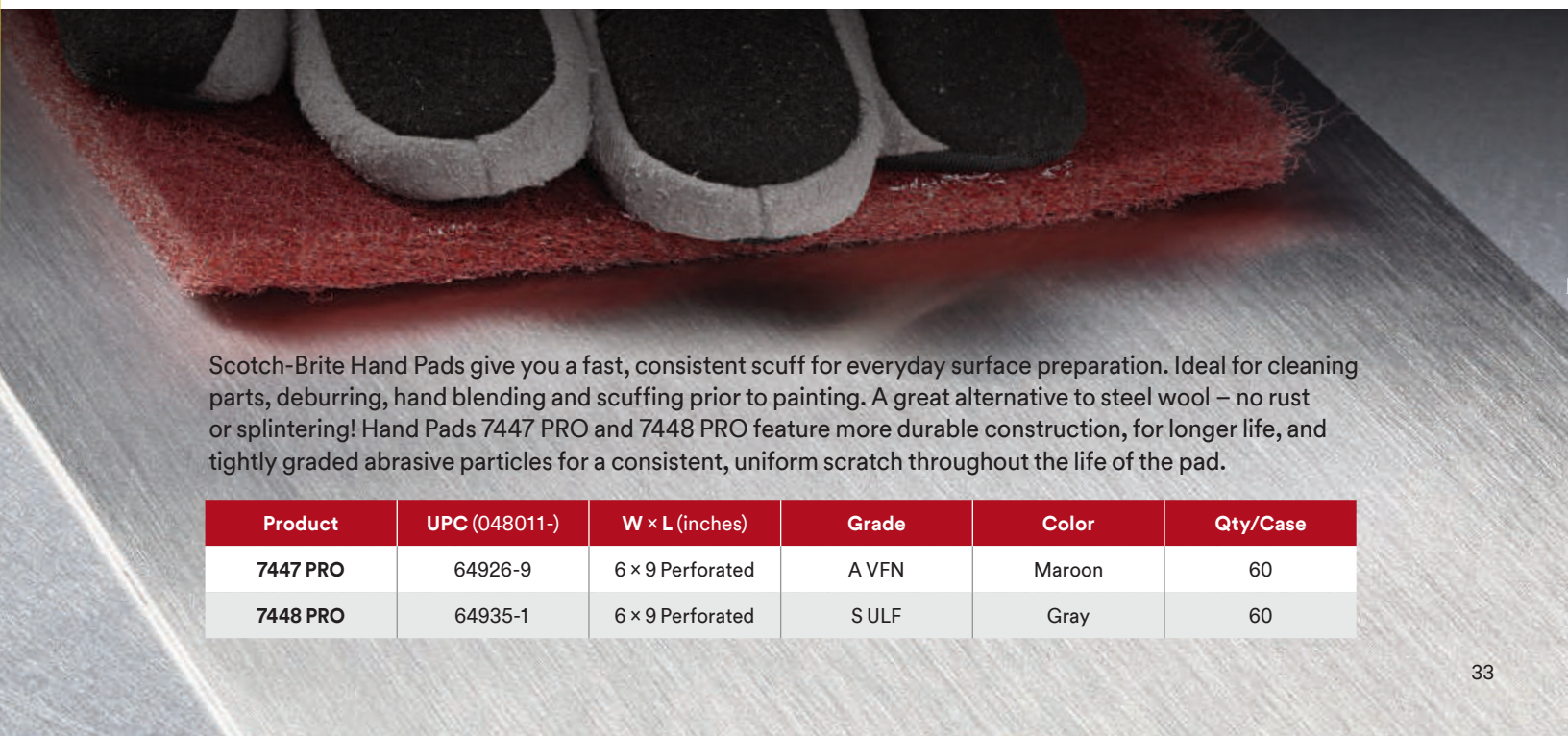

Scotch-Brite Hand Pads give you a fast, consistent scuff for everyday surface preparation. Ideal for cleaning parts, deburring, hand blending and scuffing prior to painting. A great alternative to steel wool – no rust or splintering! Hand Pads 7447 PRO and 7448 PRO feature more durable construction, for longer life, and tightly graded abrasive particles for a consistent, uniform scratch throughout the life of the pad.

Product	UPC (048011-)	W × L (inches)	Grade	Color	Qty/Case
7447 PRO	64926-9	6 × 9 Perforated	A VFN	Maroon	60
7448 PRO	64935-1	6 × 9 Perforated	S ULF	Gray	60

# 3M™ Power Tools and Accessories

**NEW!**

## 3M™ Pneumatic Power Tools

These new 1.5HP tools are engineered to help optimize the life, cut rate and consistency of fibre discs and other 3M abrasives. Designed with the operator in mind, they are easy to use and feature a robust construction for superior durability.



**3M™ Pneumatic Angle Grinder**  
06-38060-88566-6



**3M™ Pneumatic Sander**  
06-38060-88577-2

## 3M™ 1 HP Power Tools for Right-Angle Systems

These 1 HP power tools feature heavy-duty gear sets requiring no maintenance or lubrication. They are also engineered with a new sealed design that keeps external contaminants out and lubrication in.



**3M™ Grinder 28403\***  
051141-28403-3



**3M™ Grinder 28405\***  
051141-28405-7

## Power Tool and Accessory Assembly

- 3M™ Disc Pad Hub
- 3M™ Disc Pad Face Plate
- 3M™ Fibre Disc
- 3M™ Disc Retainer Nut

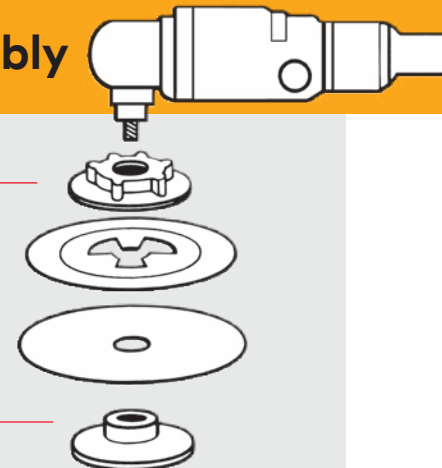



## 3M™ 1-HP Power Tools for Right-Angle Systems



3M™ Cut-Off Wheel Tool 20233  
051141-20233-4











3M™ Cut-Off Wheel Tool 28771  
051141-28771-3



For 3M™ Power Tool Warranty and Repair Service, call 1-800-362-3550.

This service is only valid in the United States.

# Accessories for 3M™ Right-Angle Systems

	Product Name	UPC	Description	Max. RPM	For Use With	Min/Case
	3M™ Disc Back-up Pad, Ribbed, Extra Hard	38060-88655-7	4 ½"	13,300	Fibre Discs and Scotch-Brite™ Surface Conditioning Discs	10
		38060-88656-4	5"	12,000		
		38060-88657-1	7"	8,600		
	3M™ Disc Back-up Pad Mounting Kit*	38060-88968-8	*Includes 3M™ Retainer Nut PN 02618, 3/16" PG Wheel Spacer and 1/8" Spacer.	NA	3M™ Disc Back-up Pads. (Not required if using the 3M™ Pneumatic Angle Grinder or 3M™ Pneumatic Sander)	1
	3M™ Disc Pad Hub - Low Profile	051141-28476-7	2 ½" dia., ½"-11"	N/A	3M™ Disc Pad Face Plates (all sizes, tool shaft length ½" or less)	10
		051144-88743-9	2 1/2" dia., 5/8-11" Metal Insert			
	3M™ Disc Pad Face Plates	051141-28443-9	4 ½" dia., Red, Ribbed, Extra Hard	13,300	Fibre Discs and Scotch-Brite™ Surface Conditioning Discs	10
		051141-14270-5	4 ½" dia., Black, Smooth, Hard	13,300		
		051144-81732-0	5" dia., Red, Ribbed, Extra Hard	12,000		
		051144-81733-7	5" dia., Black, Ribbed, Hard	12,000		
		051144-80514-3	7" dia., Red, Ribbed, Extra Hard	8,600		
		051144-80515-0	7" dia., Black, Ribbed, Hard	8,600		
	3M™ Disc Retainer Nuts	051111-51047-6	⅝" Depth; ⅝"-11" Thread	N/A	3M™ Disc Pad Face Plates and Disc Pad Hubs	N/A
		051144-05622-4	⅝" Depth; ⅝"-11" Thread	N/A		
	3M™ TN Quick Change Disc Backup Pad	051111-56573-5	4 ½" dia., ⅝"-11" INT	13,300	4 ½" TN Discs	5
	3M™ Hook-and-Loop Disc Pad Holders	051141-20245-7	7" dia., ⅝" Center Post; ⅝"-11" INT	8,500	Scotch-Brite™ Light Grinding and Blending Disc Accessories	1
		048011-14111-4	4 ½" dia., ⅝" Center Hole; ⅝" Thick, ⅝"-11" INT, Firm	13,000	Scotch-Brite™ Surface Conditioning Discs	
		048011-05680-7	5" dia., ⅝" Center Hole; ⅝" Thick, ⅝"-11" INT, Firm	10,000		
		048011-09450-2	7" dia., ⅝" Center Hole, ⅝" Thick, ⅝"-11" INT, Med.	6,000		
	3M™ Hook & Loop Disc Pad Holder CP (Center Post)	051141-28892-5	4" dia., ⅞" Center Post, ⅝"-11" INT	15,000	Scotch-Brite™ Surface Conditioning Discs	1/5
		051141-28891-8	4 ½" dia., ⅞" Center Post, ⅝"-11" INT	13,300		
		051141-28890-1	5" dia., ⅞" Center Post, ⅝"-11" INT	12,000		
		051141-28888-8	7" dia., ⅞" Center Post, ⅝"-11" INT	8,600		
	<b>New!</b> Scotch-Brite™ Universal Back Up Pad (multi-attachment)	89869	4 in. (100 mm)	15,000	Scotch-Brite™ Universal Surface Conditioning Back-Up Pad	10
		89871	5 in. (125 mm)	12,000		
		89870	4.5 in (115 mm)	13,300		



Since its beginnings in 1902, 3M has been committed to the abrasives business. Today, our line of coated abrasives, surface conditioning products and technically-enhanced power tools help metalworking businesses around the world improve performance and productivity.

No matter how tough the job, there's a 3M product to help you get it done right – and a 3M Abrasives Expert to help you find the best fit for your application.

Ask an expert:  
1-866-279-1235  
[3M.com/metalworking](http://3M.com/metalworking)

# Single Packs

	Product	Contents	Packaging	UPC
	<b>3M™ Cubitron™ II Flap Disc 967A</b> T27, 4.5 in.	1 Disc 4-½ in. × ⅞ in. Grade 40+	10/case	051125-86855-6
	<b>3M™ Cubitron™ II Flap Disc 969F</b> T27, 4.5 in.	1 Disc 4-½ in. × ⅞-11 Grade 40+	10/case	051125-87258-4
	<b>3M™ Cubitron™ II Fibre Disc 982CX Pro</b> , 4.5 in.	1 Disc 4-1/2 in. × ⅞-11 Grade 36+	10/case	06-38060-88564-2
	<b>3M™ Cubitron™ II Fibre Disc 982CX Pro</b> , 7 in.	1 Disc 7 in. × ⅞-11 Grade 36+	10/case	06-38060-88565-9
	<b>3M™ Cubitron™ II Fibre Disc 982C</b> , 4.5 in.	1 Disc 4-½ in. × ⅞ in. Grade 36+	10/case	051125-86942-3
	<b>3M™ Cubitron™ II Disc TN Quick Change 982C</b> , 7 in.	1 Disc 7 in. Grade 36+	10/case	051125-87259-1
	<b>3M™ Cubitron™ II Depressed Center Grinding Wheel T27</b> , 4.5 in. - with hub	1 Disc 4-½ in. × ¼ in. × ⅞-11	10/case	051125-87208-9
	<b>3M™ Cubitron™ II Depressed Center Grinding Wheel T27</b> , 4.5 in. - no hub	1 Disc 4-½ in. × ¼ in. × ⅞ in.	10/case	051125-87209-6
	<b>3M™ Cubitron™ II Depressed Center Grinding Wheel T27</b> , 7 in.	1 Disc 7 in. × ¼ in. × ⅞ in.	10/case	051125-87206-5
	<b>3M™ Cubitron™ II Cut-Off Wheel T27</b> , 4.5 in.	1 Disc 4-½ in. × .045 × ⅞ in. Grade 36	10/case	048011-64999-3
	<b>3M™ Cubitron™ II Cut-Off Wheel T27</b> , 6 in.	1 Disc 6 in. × .045 × ⅞ in. Grade 36	10/case	051125-87152-5
	<b>3M™ Silver Cut-Off Wheel T27</b> , 6 in.	1 Disc 6 in. × .045 × ⅞ in.	10/case	076308-44539-3
	<b>3M™ Silver Cut-Off Wheel T27</b> , 4.5 in.	1 Disc 4-½ in. × .045 in. × ⅞ in.	10/case	051125-87660-5
	<b>3M™ Silver Depressed Center Grinding Wheel T27 with Quick Change Hub</b> , 4.5 in.	1 Disc 4-½ in. × ¼ × ⅞-11 in.	10/case	051125-87661-2
	<b>3M™ Silver Depressed Center Grinding Wheel T27</b> , 4.5 in.	1 Disc 4-½ in. × ¼ in. × ⅞ in.	10/case	076308-44538-6
	<b>3M™ Cut &amp; Grind Wheel</b>	1 Disc 4-½ in. × ¼ × ⅞-11 in.	10/case	638060-75819-9



	Product	Contents	Packaging	UPC
	3M™ Fibre Disc 782C, 4.5 in.	1 Disc 4-½ in. × ⅞ in. Grade 36+	10/case	051125-87254-6
	3M™ Fibre Disc 782C, 7 in.	1 Disc 7 in. × ⅞ in. Grade 36+	10/case	051125-87255-3
	3M™ Flap Disc 769F	1 Disc 4-½ in. × ⅞ in.	10/case	638060-29883-1
	Scotch-Brite™ Roloc™+ Clean and Strip XT Pro Extra Cut Disc, TR+	1 Disc 4 in. × ½ in. A Extra Coarse	10/case	638060-29917-3
	Scotch-Brite™ Roloc™+ Clean and Strip XT Pro Disc TR+	1 Disc 4 in. × ½ in. S Extra Coarse	10/case	638060-29911-1
	Scotch-Brite™ Clean and Strip XT Pro Disc, Type 27 QC	1 Disc 4-½ in. × ⅞ - 11 in. S Extra Coarse	10/case	638060-29900-5
	Scotch-Brite™ Light Grinding & Blending Disc TN QC, 4.5 in.	1 Disc 4-½ in. × NH A Coarse	10/case	048011-65000-5
	Scotch-Brite™ Light Grinding & Blending Disc TN QC, 7 in.	1 Disc 7 in. × NH Super Duty A Coarse	10/case	076308-77124-9
	Scotch-Brite™ Precision Surface Conditioning TN Quick Change Disc	Trial Pack 4-½ in. Medium	10/case	61500-33563-5
	Scotch-Brite™ Precision Surface Conditioning TN Quick Change Disc,	Trial Pack 4-½ in. Coarse	10/case	61500-33562-7
	Scotch-Brite™ Roloc™ Precision Surface Conditioning Disc	Multi Pack 3 in.	10/case	61500-33570-0
	Scotch-Brite™ Roloc™ Precision Surface Conditioning Disc	Multi Pack 2 in.	10/case	61500-33571-8

**Call to speak with a 3M abrasives expert: 1-866-279-1235**

**Product Selection and Use:** Many factors beyond 3M's control and uniquely within user's knowledge and control can affect the use and performance of a 3M product in a particular application. As a result, customer is solely responsible for evaluating the product and determining whether it is appropriate and suitable for customer's application, including conducting a workplace hazard assessment and reviewing all applicable regulations and standards (e.g., OSHA, ANSI, etc.). Failure to properly evaluate, select, and use a 3M product and appropriate safety products, or to meet all applicable safety regulations, may result in injury, sickness, death, and/or harm to property.

**Warranty, Limited Remedy, and Disclaimer:** Unless a different warranty is specifically stated on the applicable 3M product packaging or product literature (in which case such warranty governs), 3M warrants that each 3M product meets the applicable 3M product specification at the time 3M ships the product. 3M MAKES NO OTHER WARRANTIES OR CONDITIONS, EXPRESS OR IMPLIED, INCLUDING, BUT NOT LIMITED TO, ANY IMPLIED WARRANTY OR CONDITION OF MERCHANTABILITY, FITNESS FOR A PARTICULAR PURPOSE, OR ARISING OUT OF A COURSE OF DEALING, CUSTOM, OR USAGE OF TRADE. If a 3M product does not conform to this warranty, then the sole and exclusive remedy is, at 3M's option, replacement of the 3M product or refund of the purchase price.

**Limitation of Liability:** Except for the limited remedy stated above, and except to the extent prohibited by law, 3M will not be liable for any loss or damage arising from or related to the 3M product, whether direct, indirect, special, incidental, or consequential (including, but not limited to, lost profits or business opportunity), regardless of the legal or equitable theory asserted, including, but not limited to, warranty, contract, negligence, or strict liability.



**Abrasive Systems Division**  
3M Center, Building 223-6N-02  
St. Paul, MN 55144-1000  
1-866-279-1235  
[www.3M.com/abrasives](http://www.3M.com/abrasives)

Please recycle. Printed in USA.  
© 3M 2022. All rights reserved.  
Issued: 4/22 17088HB  
61-5002-8389-2 Rev. H

Norton is a registered trademark of St. Gobain.  
3M, Cubitron, Scotch-Brite, SecureFit, E-A-R, Speedglas  
and UltraFit are trademarks of 3M Company. Used under  
license by 3M subsidiaries and affiliates.



## 3M™ Metalworking Tools

3M™ Pneumatic Grinders, Disc Sander and Cut-Off Wheel Tool



# Bring Out The Power

Optimize the performance of your 3M™ Abrasives – with these powerful new tools from 3M. Designed to make your job faster, easier and more productive!

**3M**

# Engineered to give you more.

- ✓ More Power
- ✓ More Productivity
- ✓ More Cutting-Edge Abrasive Performance

Now you can tap in to the full potential of advanced 3M™ Abrasives – with a matching power tool lineup that re-writes the rules for metalworking performance and productivity!

The 3M™ Pneumatic Grinders, Disc Sander and Cut-Off Wheel Tools shown on these pages are the latest additions to the 3M™ Power Tool line. Each has been carefully designed to give you the highest possible level of performance from our next-generation abrasive products – including 3M™ Cubitron™ II Abrasives with proprietary precision shaped grain, proven to cut faster, cooler and up to 4 times longer than the next-best competitive abrasive.

These professional-grade tools are designed specifically to help you tackle today's tough metalworking challenges. Lightweight and powerful, with a high-torque, 1 HP motor, these tools are reliable, easy to control and easy for operators to use.

- **1 HP, high torque motor** – Allows operator to maintain higher unit pressure without stalling the tool. Grinds faster, for more parts per shift.
- **3/8" Air inlet with 1/4" reducer** – Improves tool performance, even with less than optimal compressed air delivery systems.
- **Polymer encased metal motor housing** – Provides stable temperature, for more operator comfort.
- **3M™ Gripping Material molded into tool housing** – Allows greater control with less gripping force.
- **Right angle steel gear head with grease fitting** – Helps extend gear life, improve reliability.
- **Removable & repositionable side handle** – Accommodates right-hand or left hand use. Allows operators to run the tool comfortably from any angle.
- **360 degree rotatable guard** – (on grinders and cut-off wheel tool) – Makes it easier to get into hard to reach areas. Provides 180 degrees of protection and better visibility of the work surface, for more operator safety.

Precision extension bearings for accurate motor extension alignment and added rigidity

Double upper shaft bearings provide improved shaft stability and longer bearing life

Steel gear head casing enhances durability under high-force applications

Precision steel spline coupler allows accurate motor extension and improved smoothness

Steel extension housing, for low vibration and longer life

Precision valve system provides accurate intermediate speed control

Durable muffler with superior noise reduction

Hardened steel rotor improves motor functionality, while enabling superior balance and smoothness

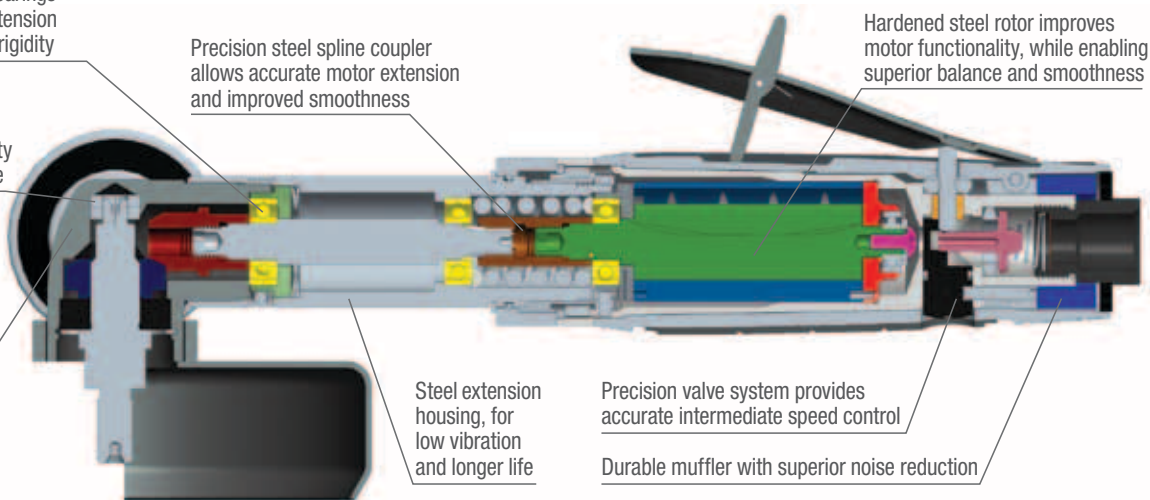

All tools are in stock and ready to ship!

### 3M™ Grinders – 4.5", 5/8-11 EXT

For use with 4.5" abrasive discs or wheels including:

- 3M™ Roloc™ Discs
- 3M™ Flap Discs
- Scotch-Brite™ Discs
- 3M™ Fibre Discs
- 3M™ Bonded Wheels

Tool	Part No.	UPC	Diameter	Thread	RPM	Motor	Air Inlet
T-27 Grinder 4.5", Standard	28405	051141-28405-7	4 1/2"	5/8-11 EXT	12,000	1 HP	3/8" NPT*
T-27 Grinder 4.5", Extended	28414	051141-28414-9	4 1/2"	5/8-11 EXT	12,000	1 HP	3/8" NPT*

\* Includes 3/8" to 1/4" reducer



Removable and repositionable side handle furnished with tool. Guard can be positioned for greater visibility of the work surface/area.

Use for general metal fabrication applications – grinding, blending, weld leveling, metal prep, pipe notching.

The extended version of the 4.5 inch grinder is ideal for hard to reach areas. The addition of a second grip places operator's hand further from the grinding area, for safer operation. Precision steel spline coupler provides accurate motor extension alignment and improved smoothness.

### 3M™ Grinders – 4", 3/8-24 EXT

For use with 4" abrasive discs or wheels including:

- 3M™ Roloc™ Discs
- 3M™ Bonded Wheels
- Scotch-Brite™ Discs
- 3M™ Fibre Discs

Tool	Part No.	UPC	Diameter	Thread	RPM	Motor	Air Inlet
T-27 Grinder 4", Standard	28403	051141-28403-3	4"	3/8-24 EXT	12,000	1 HP	3/8" NPT*
T-27 Grinder 4", Extended	28413	051141-28413-2	4"	3/8-24 EXT	12,000	1 HP	3/8" NPT*

\* Includes 3/8" to 1/4" reducer



Removable and repositionable side handle furnished with tool. Guard can be positioned for greater visibility of the work surface/area.

Applications include weld leveling/blending, metal prep, plasma cut clean-up. Commonly used in ship building and other metal fabrication applications that use smaller abrasives.

The extended version of the 4 inch grinder is ideal for hard to reach areas. The addition of a second grip places operator's hand further from the grinding area, for safer operation. Precision steel spline coupler provides accurate motor extension alignment and improved smoothness.

### 3M™ Disc Sander – 4-5", 5/8-11 EXT

For use with 4", 4 1/2" and 5" abrasive discs including:

- 3M™ Roloc™ Discs
- Scotch-Brite™ Discs
- 3M™ Fibre Discs

Tool	Part No.	UPC	Diameter	Thread	RPM	Motor	Air Inlet
Disc Sander	28408	051141-28408-8	4"-5"	5/8-11 EXT	12,000	1 HP	3/8" NPT*

\* Includes 3/8" to 1/4" reducer



Removable side handle furnished with tool. Ideal for general metal fabrication applications, including grinding, blending, weld leveling and metal prep. Also suitable for coating removal and metal prep using 4.5" bristle discs.

### 3M™ Cut-Off Wheel Tool, Extended – 4", 3/8-24 EXT

For use with 4" cut-off wheels

Tool	Part No.	UPC	Diameter	Thread	RPM	Motor	Air Inlet
Cut-Off Wheel Tool Extended	28407	051141-28407-1	4"	3/8-24 EXT	18,000	1 HP	3/8" NPT*

\* Includes 3/8" to 1/4" reducer



This right angle cut-off wheel tool with guard features a removable and repositionable side handle. Guard can be positioned for greater visibility of the work surface. Right angle steel extended gear head with grease fitting provides extended reach and increased gear life.

Commonly used in ship building and other metal fabrication applications where it is preferable to use 4 inch cut-off wheels at a right angle to the tool body.

# Warranty and Repair Service

3M™ Metalworking Tools

## For more information

Contact your 3M Distributor  
or 3M Sales Representative

▶ **Or Call 3M at 1-800-362-3550**

- Press Option 3  
(Product Complaints)
- Then Option 4 (for Abrasives  
Tools and accessories)

**Product Use:** All statements, technical information and recommendations contained in this document are based on tests or experience that 3M believes are reliable. However, many factors beyond 3M's control can affect the use and performance of a 3M product in a particular application, including the conditions under which the 3M product is used and the time and environmental conditions in which the product is expected to perform. Since these factors are uniquely within the user's knowledge and control, it is essential that the user evaluate the 3M product to determine whether it is fit for a particular purpose and suitable for the user's method of application.

**Warranty and Limited Remedy:** 3M warrants this tool against defects in workmanship and materials under normal operating conditions for one (1) year from the date of purchase. 3M MAKES NO OTHER WARRANTIES, EXPRESS OR IMPLIED, INCLUDING, BUT NOT LIMITED TO, ANY IMPLIED WARRANTY OF MERCHANTABILITY OR FITNESS FOR A PARTICULAR PURPOSE OR ANY IMPLIED WARRANTY ARISING OUT OF A COURSE OF DEALING, CUSTOM OR USAGE OF TRADE. User is responsible for determining whether the 3M tool is fit for a particular purpose and suitable for a user's application. User must operate the tool in accordance with all applicable operating instructions, safety precautions, and other procedures stated in the operating manual to be entitled to warranty coverage. 3M shall have no obligation to repair or replace any tool or part that fails due to normal wear, inadequate or improper maintenance, inadequate cleaning, non-lubrication, improper operating environment, improper utilities, operator error or misuse, alteration or modification, mishandling, lack of reasonable care, or due to any accidental cause. If a tool or any part thereof is defective within this warranty period, your exclusive remedy and 3M's sole obligation will be, at 3M's option, to repair or replace the tool or refund the purchase price.

**Limitation Of Liability:** Except where prohibited by law, 3M and seller will not be liable for any loss or damage arising from the 3M product, whether direct, indirect, special, incidental, or consequential, regardless of the legal theory asserted, including warranty, contract, negligence or strict liability.



### Abrasive Systems Division

3M Center, Building 223-6N-02  
St. Paul, MN 55144-1000  
1-866-279-1235  
[www.3M.com/abrasives](http://www.3M.com/abrasives)

Please recycle. Printed in USA.  
© 3M 2011. All rights reserved.  
Issued: 5/11 8029HB  
61-5002-8297-7

3M, Cubitron, Roloc and Scotch-Brite  
are trademarks of 3M Company.  
Used under license by 3M subsidiaries  
and affiliates.